

Cartão de Natal em 3D

Colorir, recortar e montar. Inclui uma variedade de desenhos para você decorar seus cartões de Natal em vários estilos.

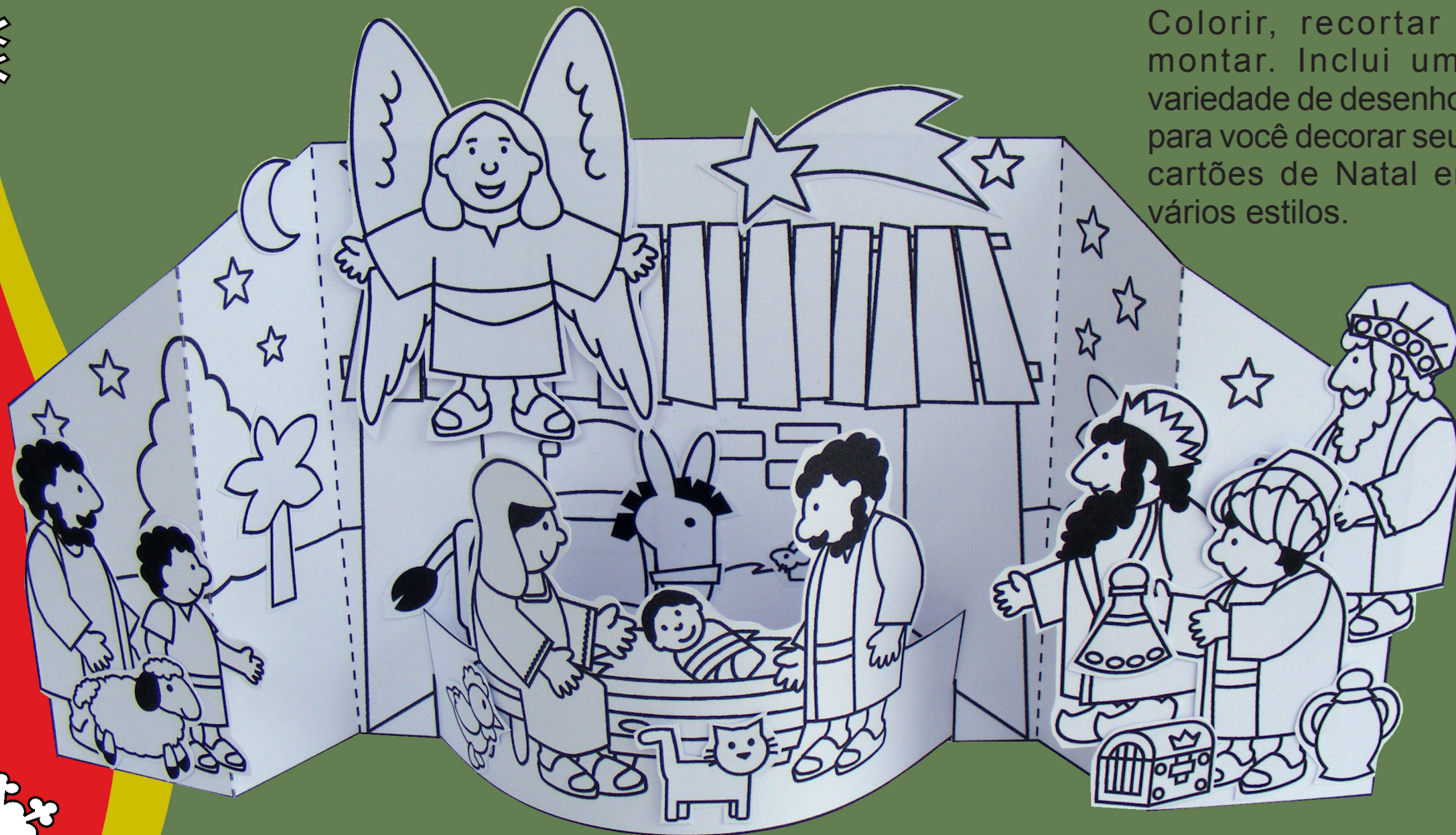

Imprimir as páginas 2, 3 e 4 em cartolina. Depois é só seguir as instruções para fazer o seu cartão. O cartão foi concebido para caber num envelope para cartão postal. Consultar a página 6 para algumas ideias adicionais.

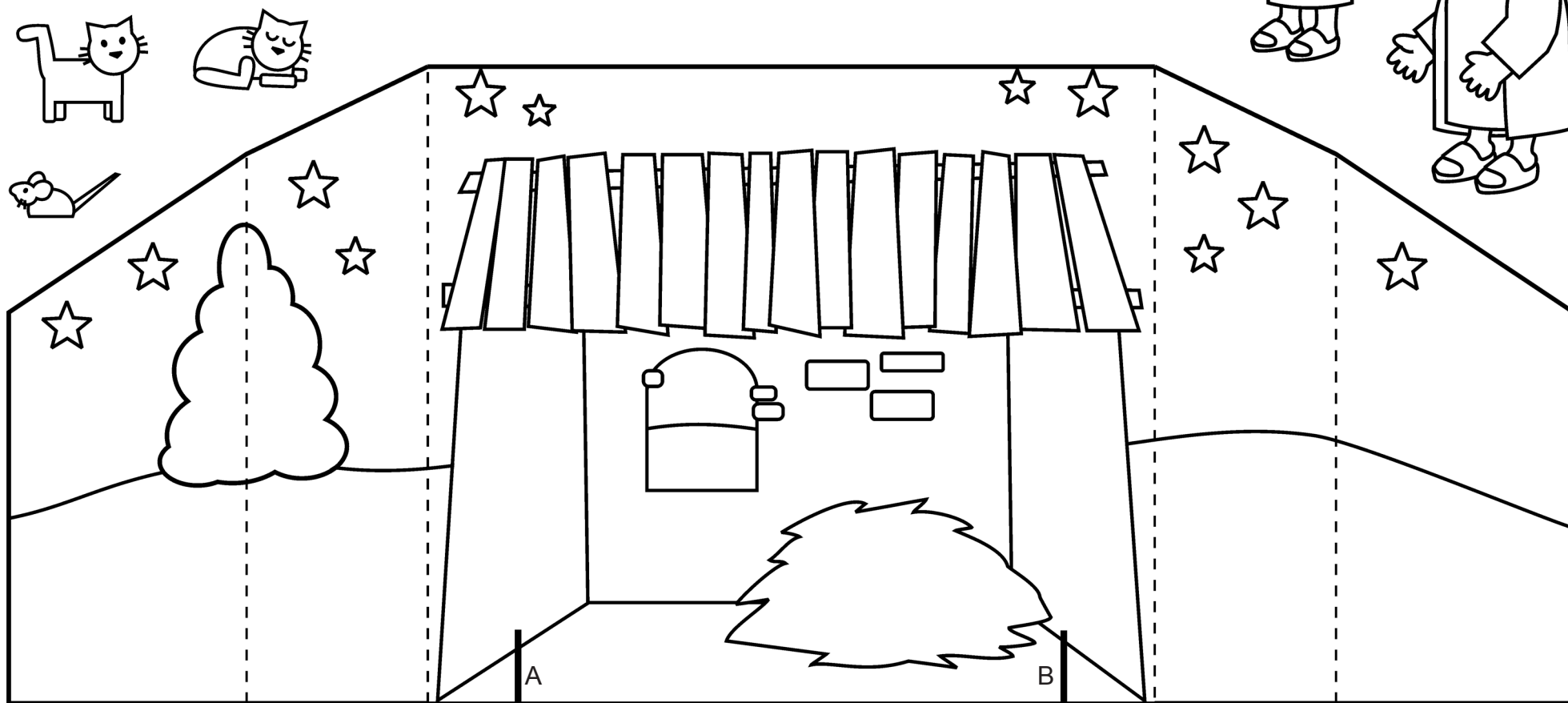
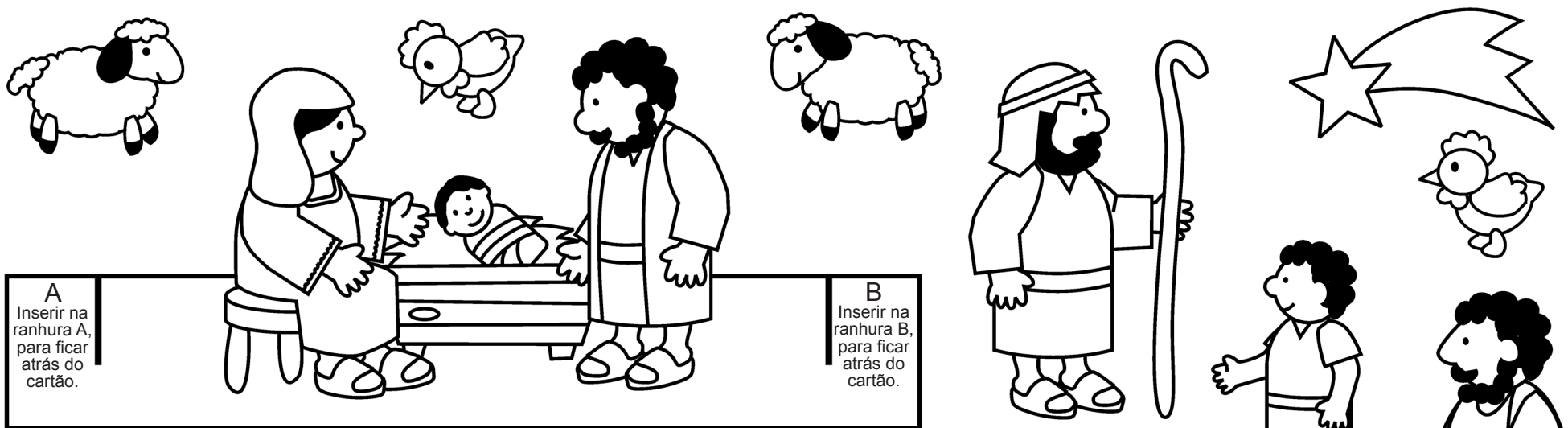

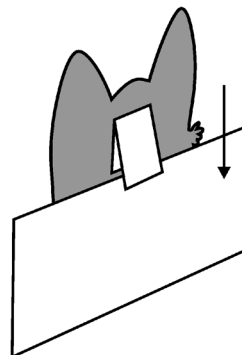
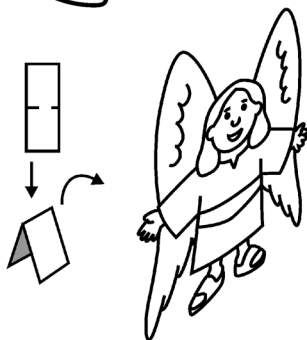

Recortar a pequena tira de papel e dobrar ao meio. Com a parte de cima, colar a parte da frente da aba na parte superior das costas do anjo. Agora o anjo pode ficar suspenso em cima do cartão.

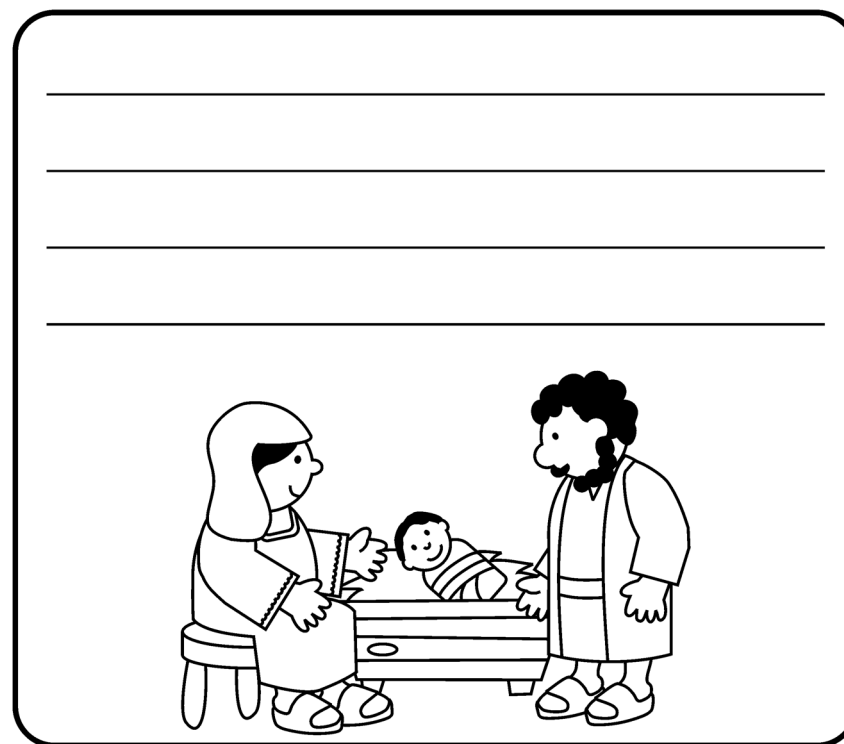
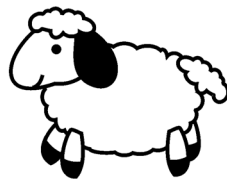
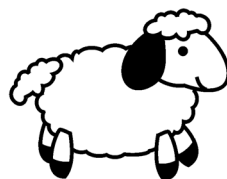

Escreva aqui a sua saudação de Natal.
Recorte e cole no verso do cartão.

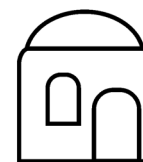
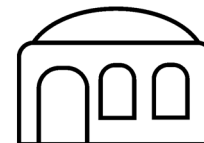
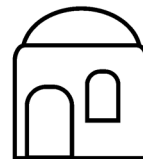
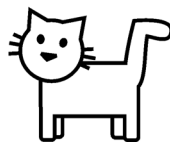
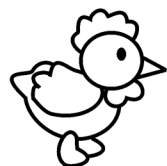
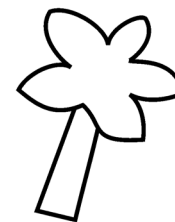
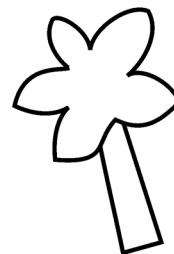
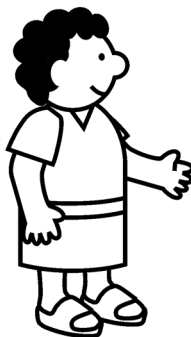
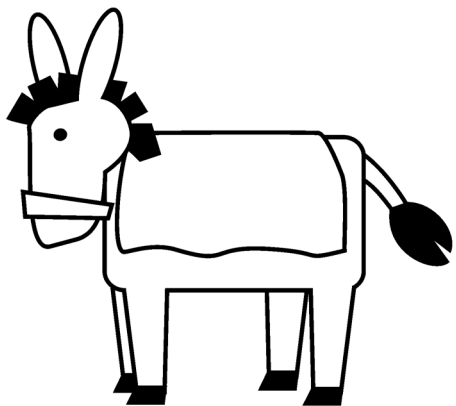
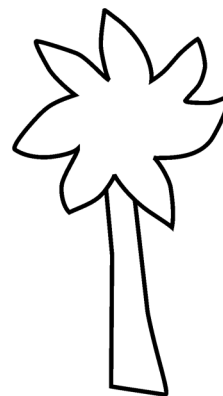
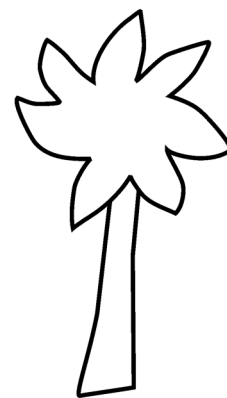
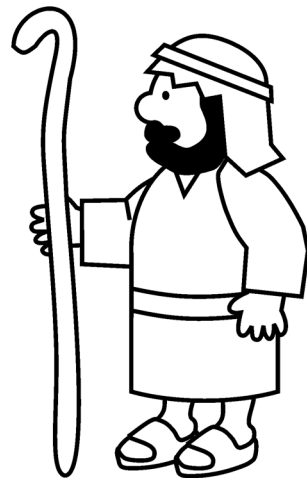

Cómo montar o seu cartão de Natal

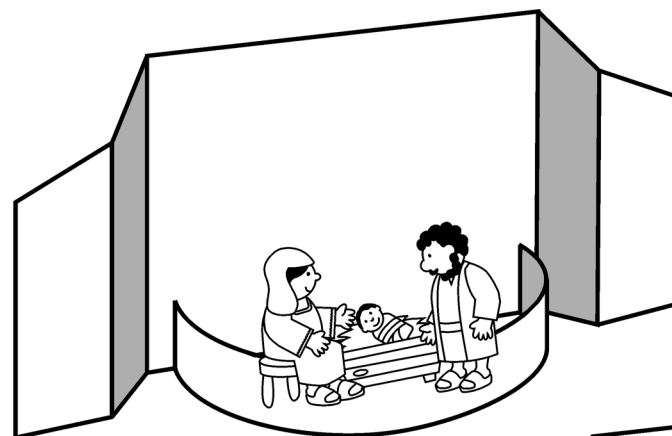
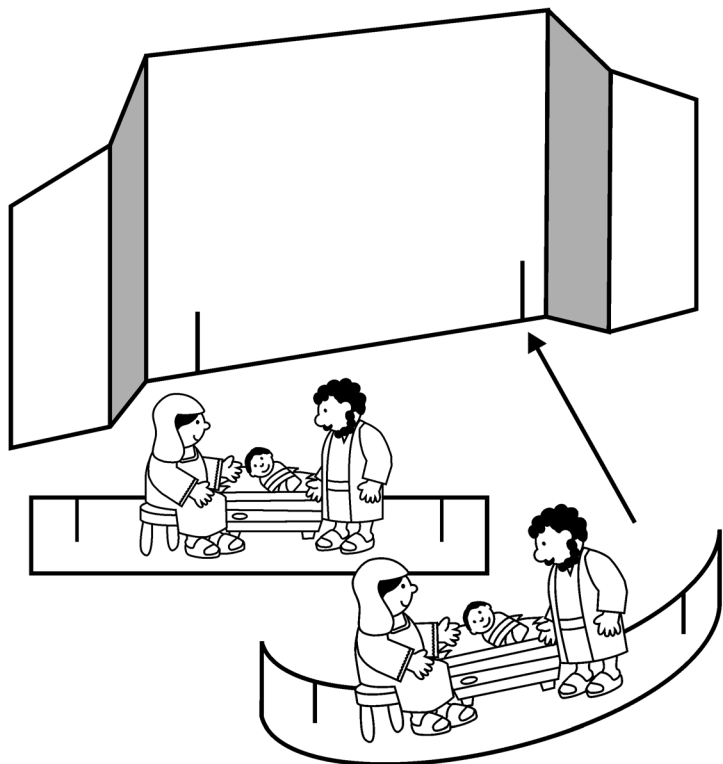

Para colocar o seu cartão dentro do envelope, primeiro remova a tira de papel com a cena do presépio. Depois dobre as abas dentro e coloque o cartão, a tira e o anjo dentro do envelope.

1. Recortar a moldura do cartão pela linha grossa. Em seguida, dobrar ao longo da linha pontilhada como mostra o desenho aqui. Depois, recortar as duas linhas grossas, que são para inserir a tira de papel comprida, como mostra a ilustração acima.

2. Colorir e recortar a tira de papel comprida com o desenho do presépio. Colorir as duas linhas grossas, e depois dobrar ligeiramente para formar um arco.

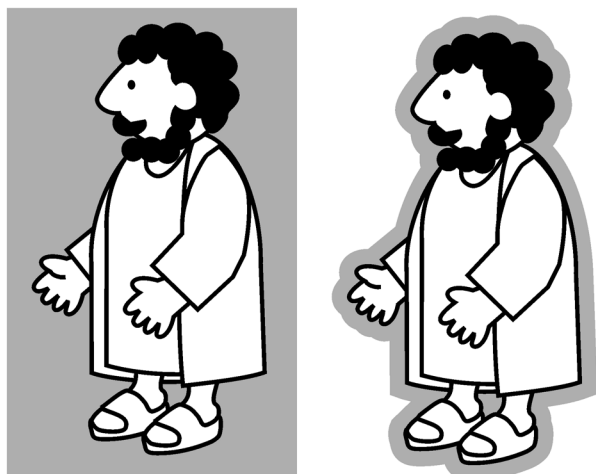
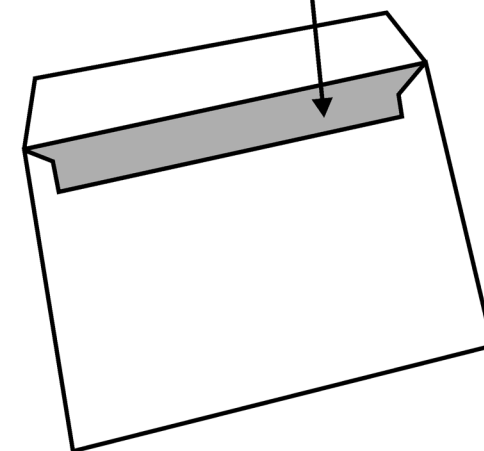
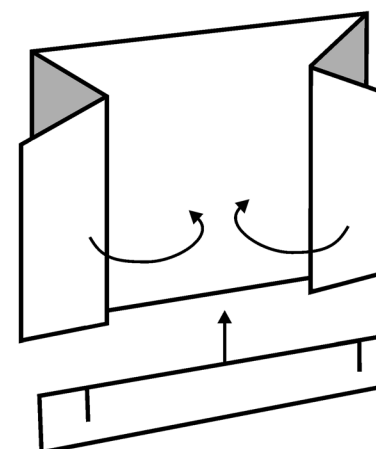

Quando recortar as gravuras, não precisa cortar exatamente em cima da linha preta. Basta recortar a alguns milímetros de distância da gravura.

- Colorir o fundo do cartão, colorir e recortar as várias gravuras para dispor no cartão formando o presépio.
- Você pode usar glitter colorido ou pequenas estrelas brilhantes para decorar o seu cartão.
- Você pode usar o modelo da página seguinte para criar o seu próprio presépio e desenhar suas próprias gravuras. Talvez queira usar papel colorido ou outros materiais para decorar o seu cartão.

Modelos

Pode usar os modelos para criar seu próprio cartão de Natal ou criar outros cartões a partir da ideia apresentada nas páginas anteriores.

Também pode fazer um cartão mais simples cortando um papel do tamanho do seu envelope e usando as gravuras deste projeto para decorá-lo.

